

Unitary Aux Heater Installation and Setup

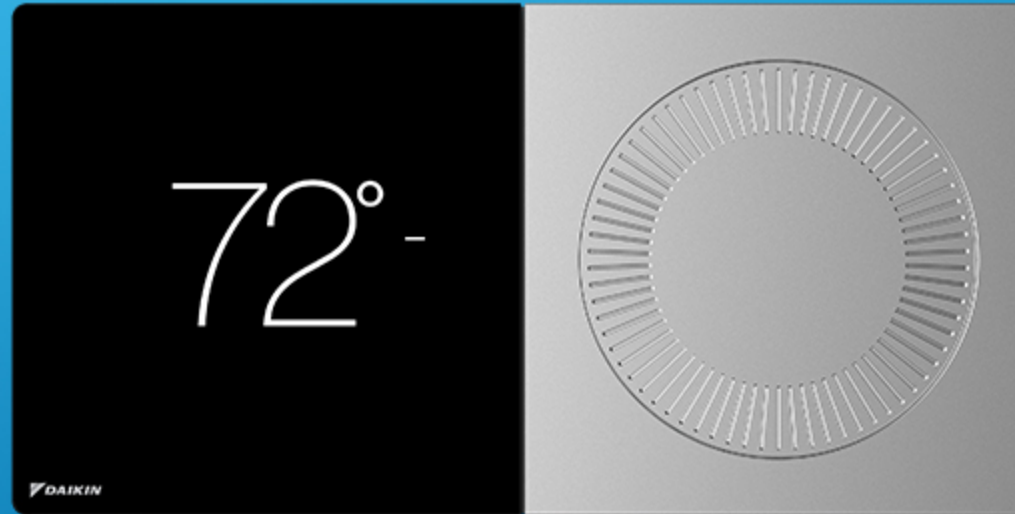

Aux wiring

- The thermostats Aux outputs are dry contacts that close the connection to turn on the Aux equipment.
- A 24V AC control signal must be routed through one of the aux contacts of the thermostat.

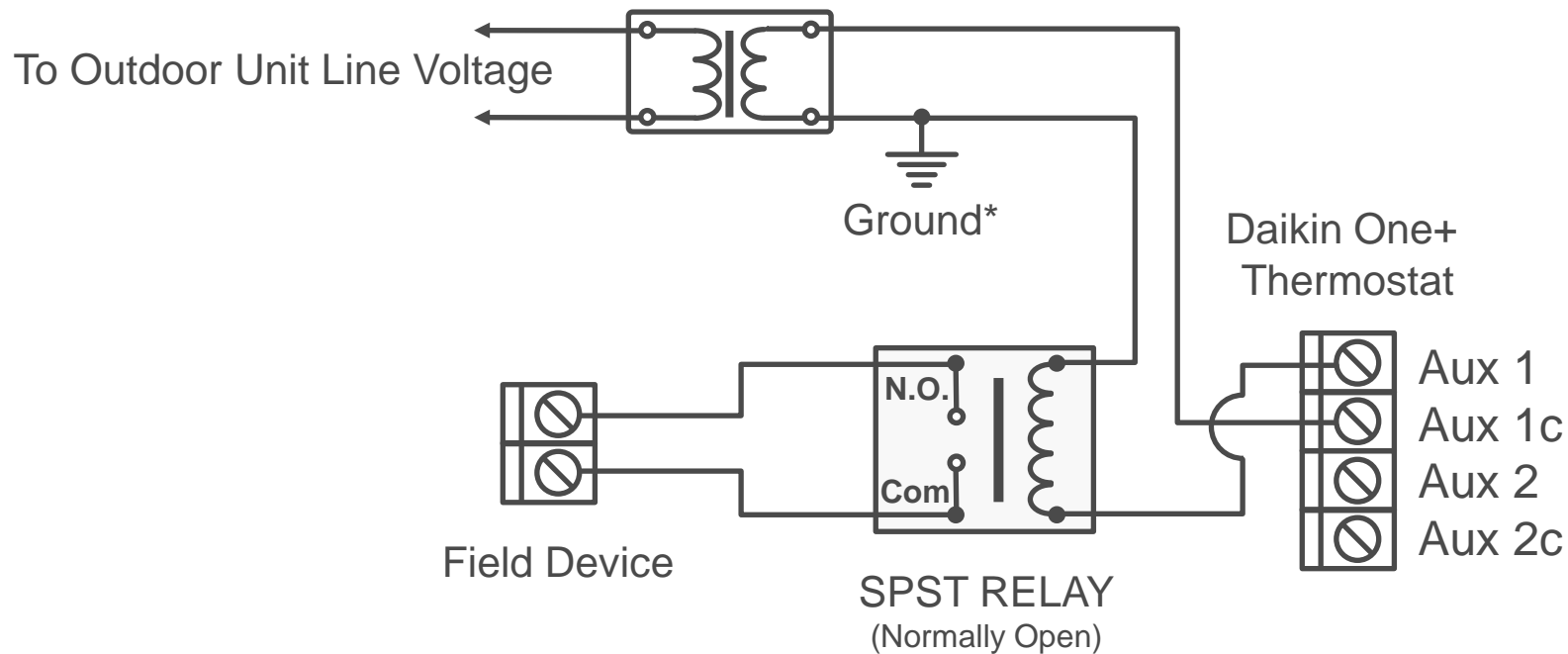

*The terminals are selected in the Daikin One+ installer wizard.
Note: It is recommended to use a minimum of 18-gauge wire.
Maximum operating length of wire is 125 ft.

Aux Heat Setup on Daikin One+

Add Equipment – Auxiliary Heat

- Selecting add equipment will allow you to configure an auxiliary heat source.

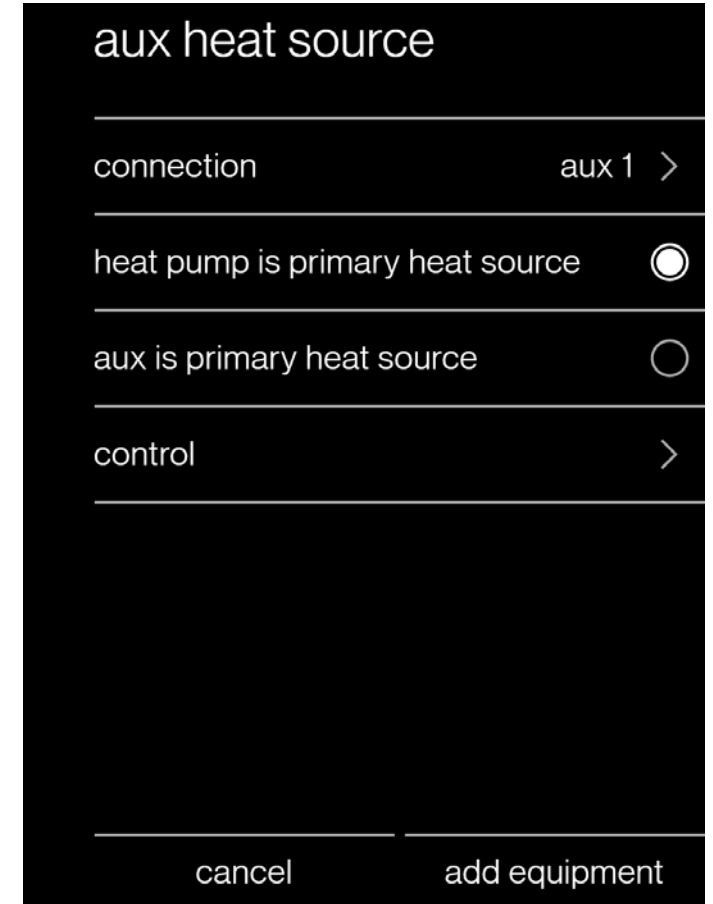
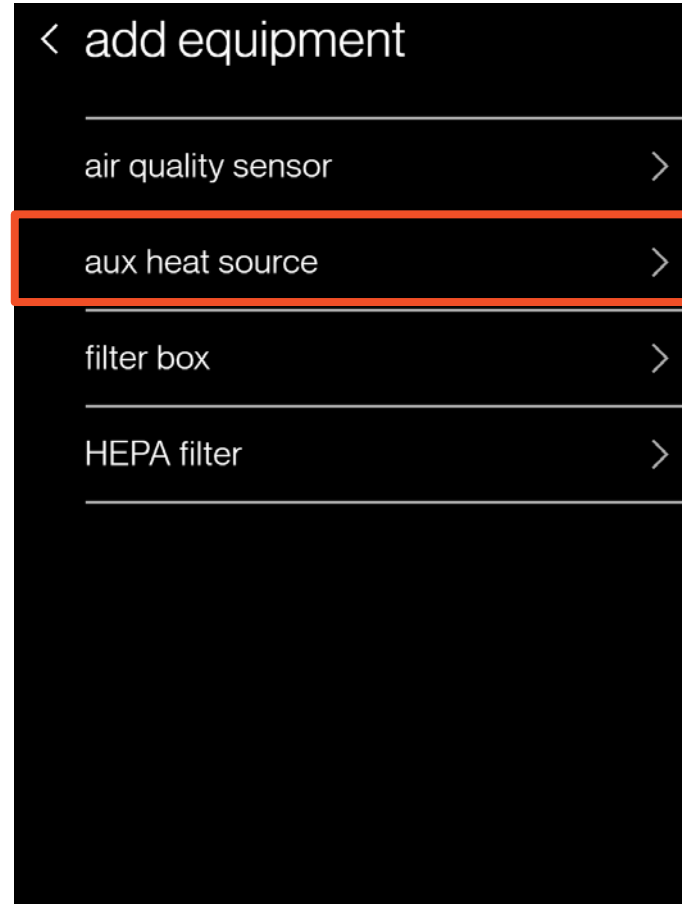
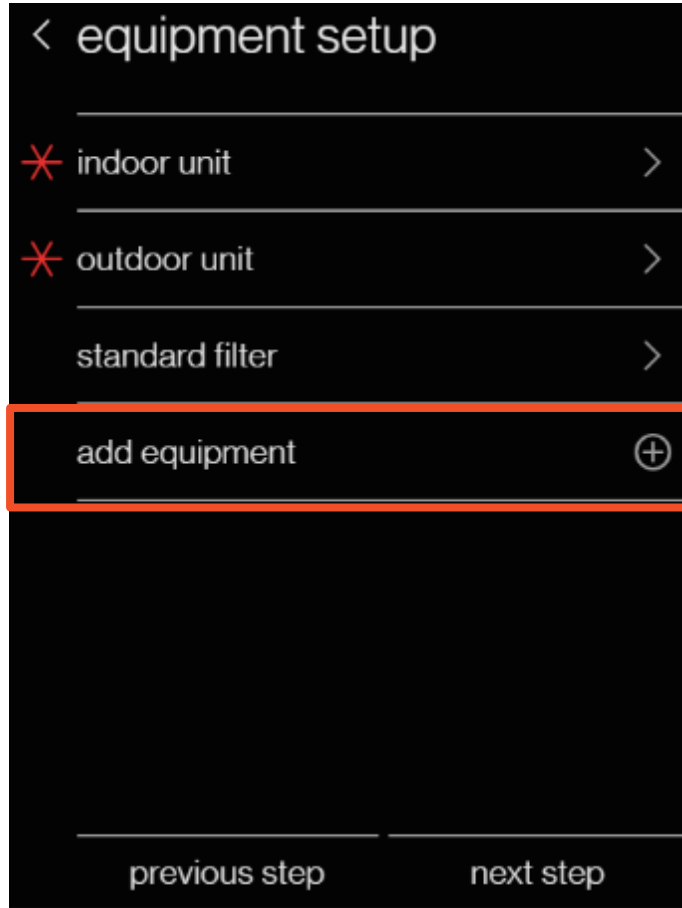

Aux Heat Setup on Daikin One+

Secondary Heat Settings

- The control section will allow you to adjust settings such as lockouts and secondary heat activation temperature.

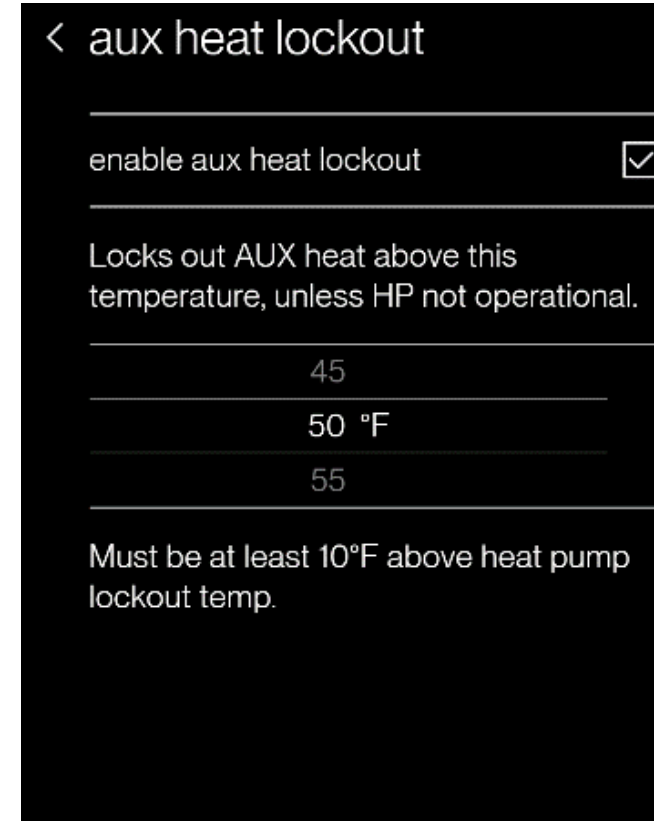
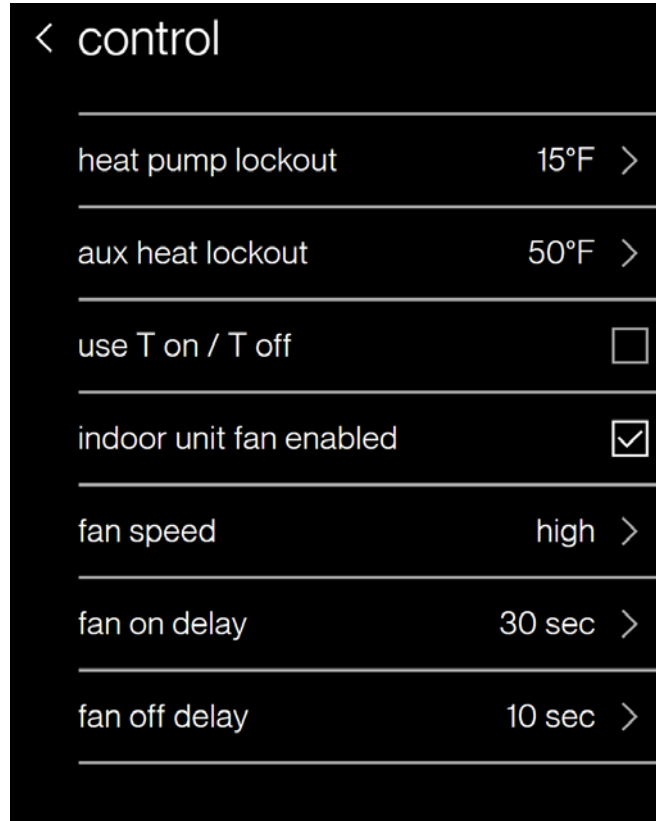

***Emergency Heat mode will appear as a system mode when connected to heat pump units and can be used to directly turn on the aux heat source if enabled.**

T on/T off Control

- T on and T off provide an alternative control method to have the main AC/heat pump control the aux heat source using its PI control algorithm.
- T on/T off is the only control option for AC- only outdoor units
 - If the indoor unit is a gas furnace, or is an air handler with a heater strip, these heat sources will be controlled around the heat setpoint by the demand-based algorithm.
 - The aux heat source will be controlled independently.

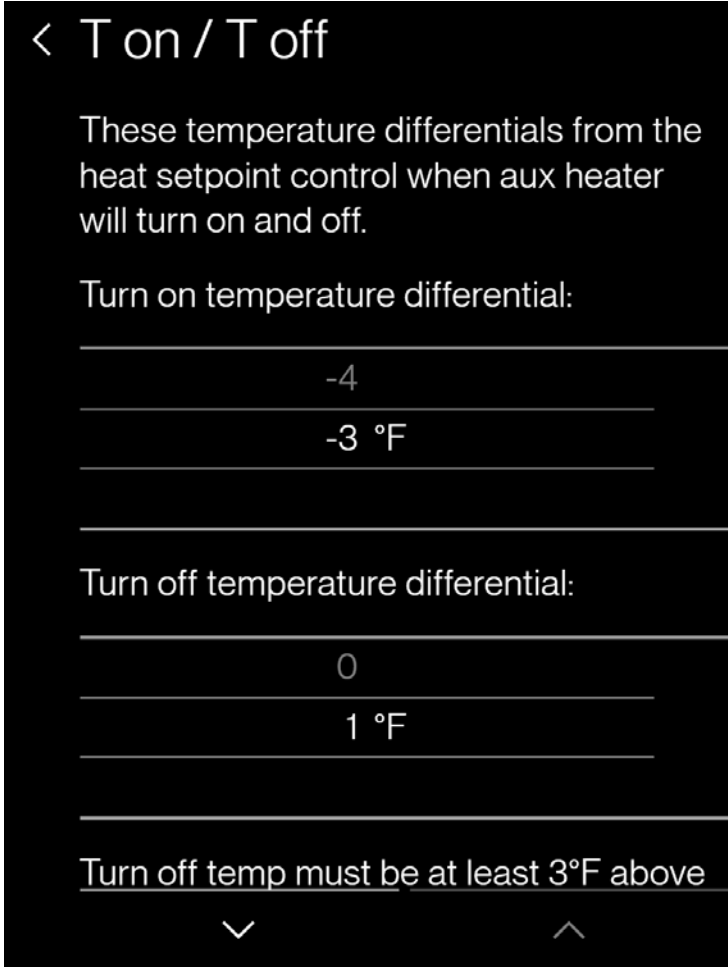
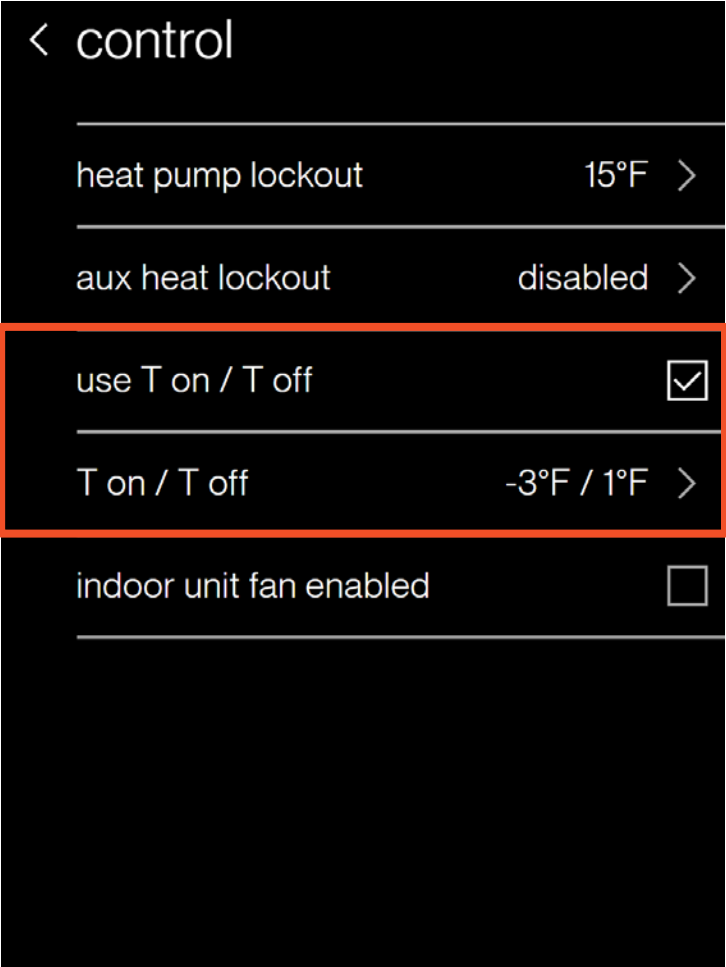

Heat Pump as Primary Heat Source

- When heat pump is the primary heat source:
 - Heat pump lockout temperatures are adjustable from -20°F to 65°F in 5°F increments. (default 15°F)
 - Auxiliary heat lockout temperatures are adjustable from -10°F to 75°F in 5°F increments. (default 50°F)

Auxiliary heat demand:

- T on differential is adjustable from -7°F to -3°F in 1°F increments (default -3°F)
- T off differential is adjustable from -4°F to 1°F in 1°F increments (default 1°F)

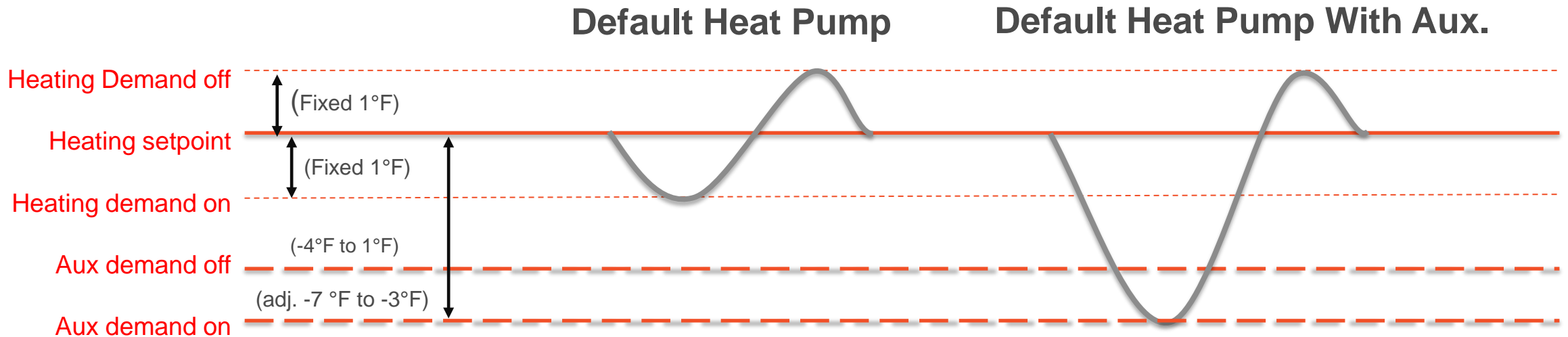

Auxiliary Heat as Primary Heat Source

- When auxiliary heat is the primary heat source:
 - Heat pump lockout temperatures are adjustable from -20°F to 65°F in 5°F increments. (default 15°F)
 - Setpoint differential can be set at -9°F, -7°F, -4°F, and -2°F (default -2°F)

Heat pump demand:

- T on differential can be set at -1°F or -2°F (default -1°F)
- T off differential 1°F fixed

