

New Daikin *One+* Initial Software Update

AUGUST 11, 2020



Have a setup board/backboard to work with.



Install baseplate of the Daikin *One+* to the board.



Attach power supply to the baseplate.

NOTE:

- Each Thermostat requires 24VAC/DC.



Attach thermostat to the baseplate and apply power.

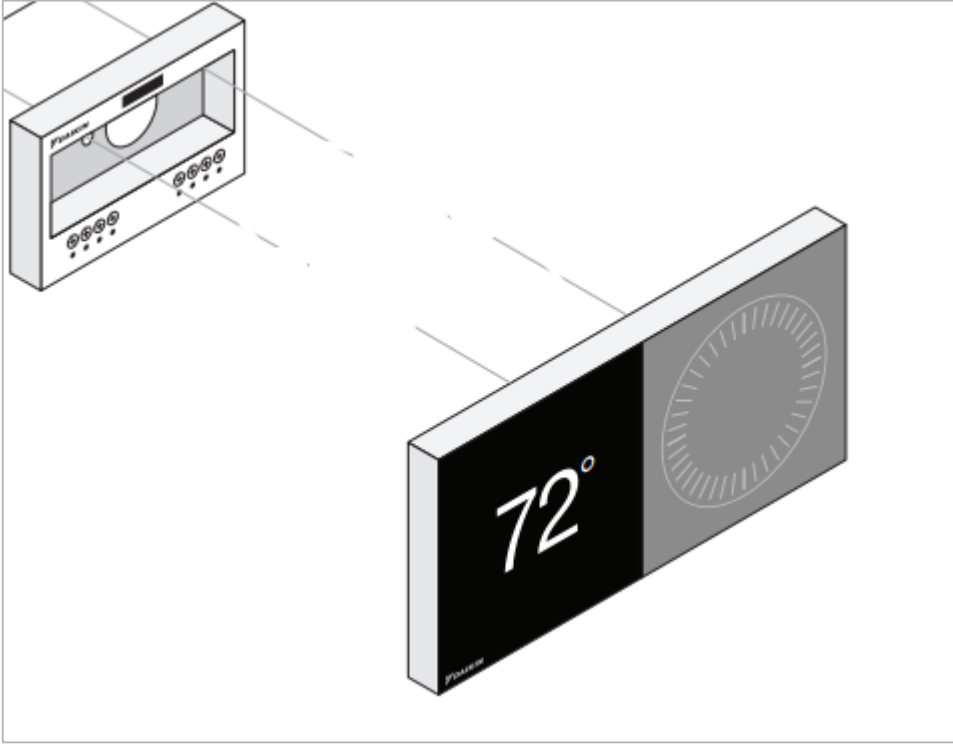

Connect to the network and software will update automatically.

- Note: For thermostats with software version 2.1.X or newer

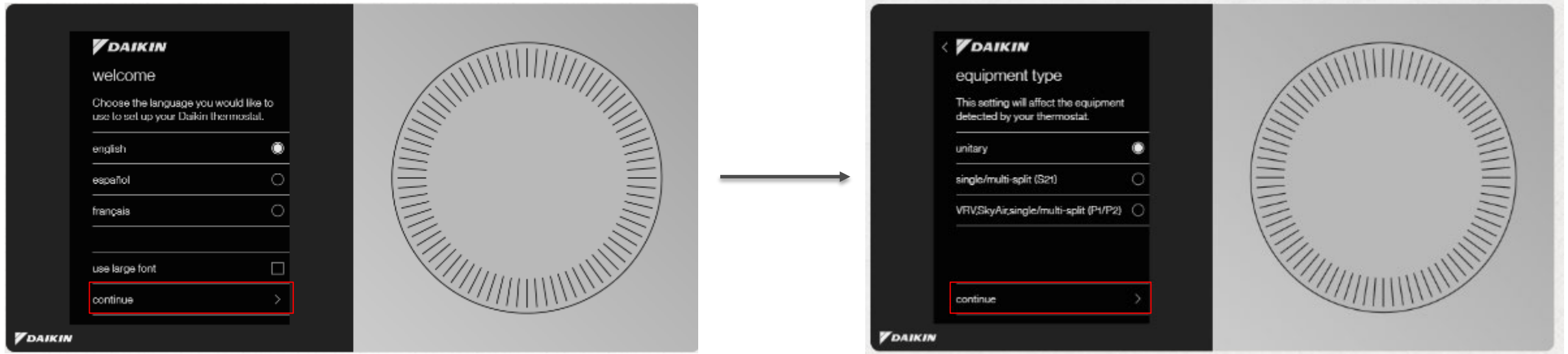

Connect to the network and software will update automatically (con't).

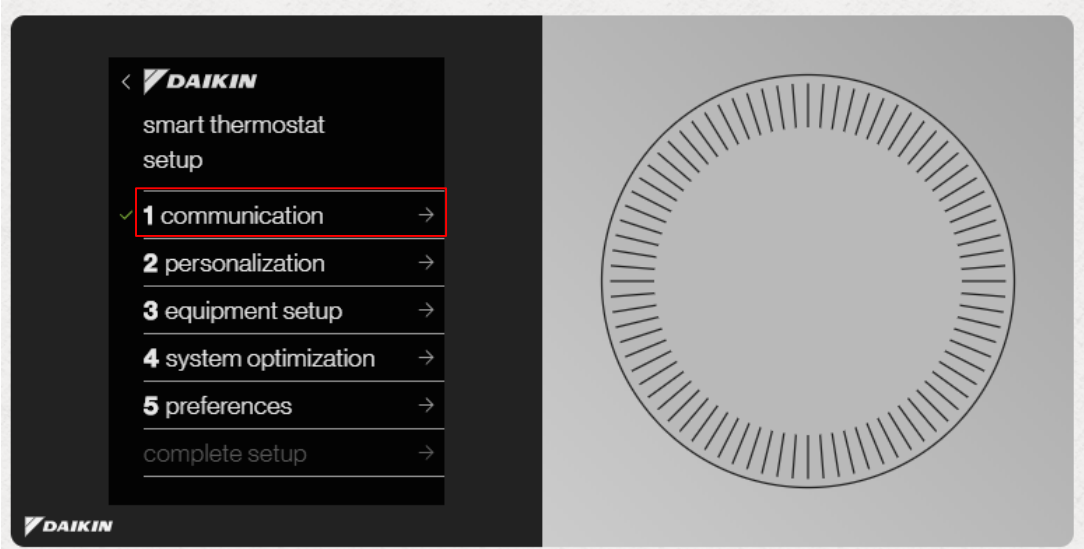
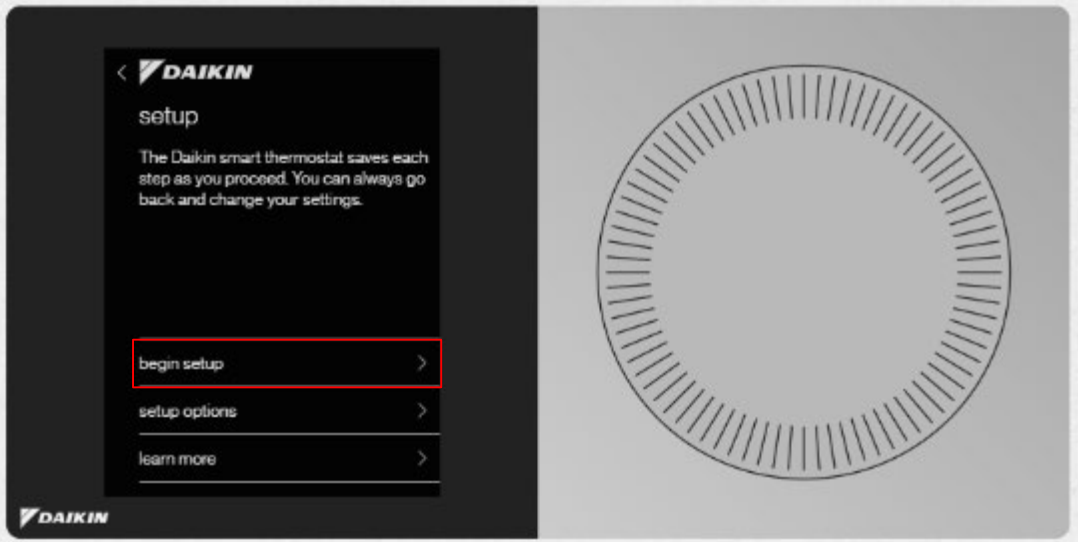

Connect to the network and software will update automatically (con't).

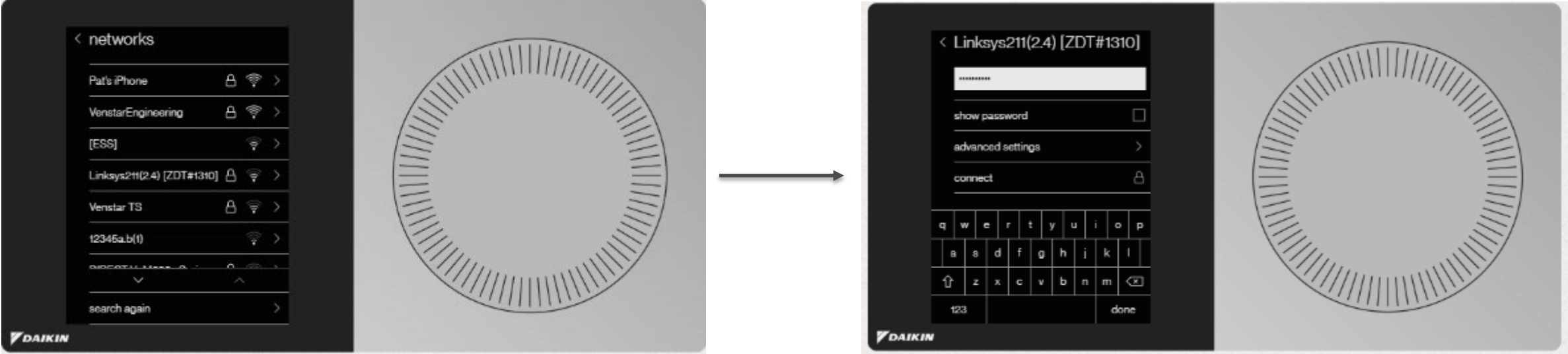

Connect to the network and software will update automatically (con't).

- Note: Once connected to the internet this screen should show



Connect to the network and software will update automatically (con't).

- Note: Once connected to Dakin Cloud you will see these screens.

1.

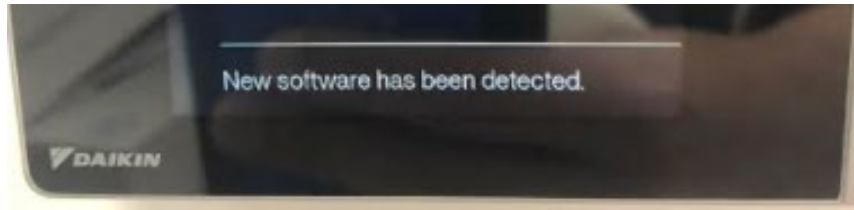

2.



3.

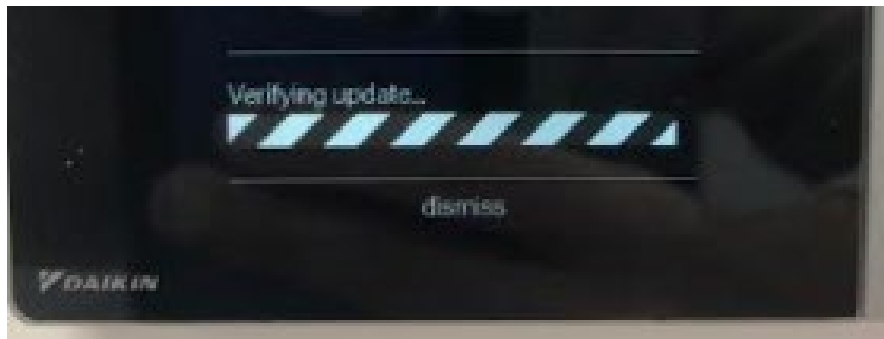

4.

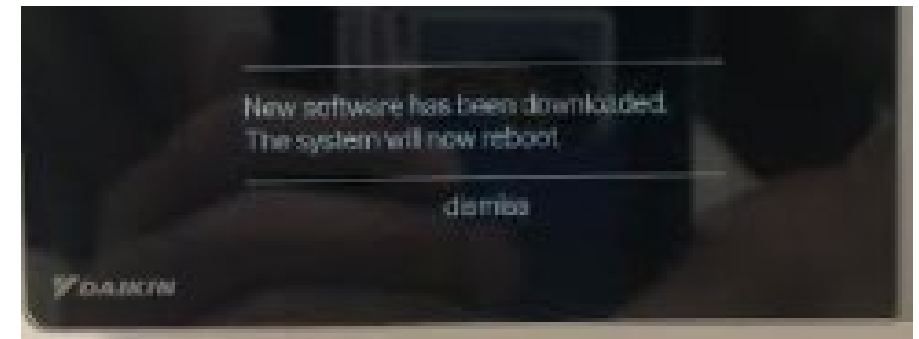

Verify the thermostat software is updated to **the latest (v2.1.16 on 10/19/2020)**.

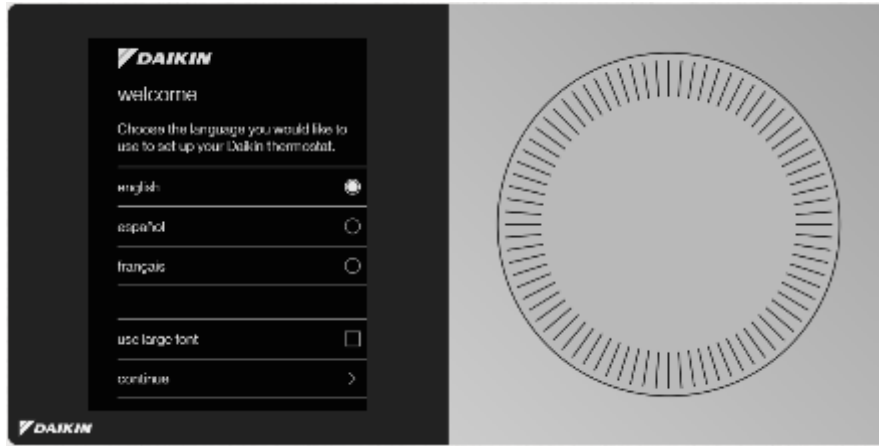

Click on Continue

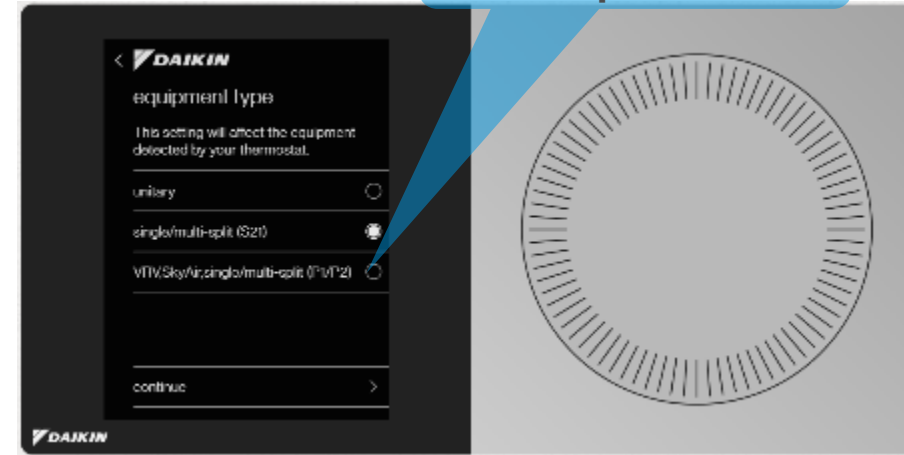

Select P1/P2 option

Click on Continue

Click on Learn More

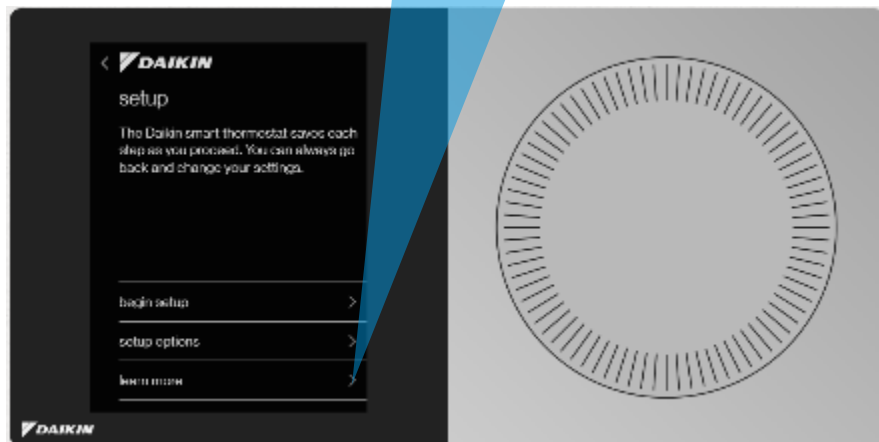

Click on Continue

Verify software is updated



Connect to the network and software will update automatically.

- Note: For thermostats with software 1.6.X or older

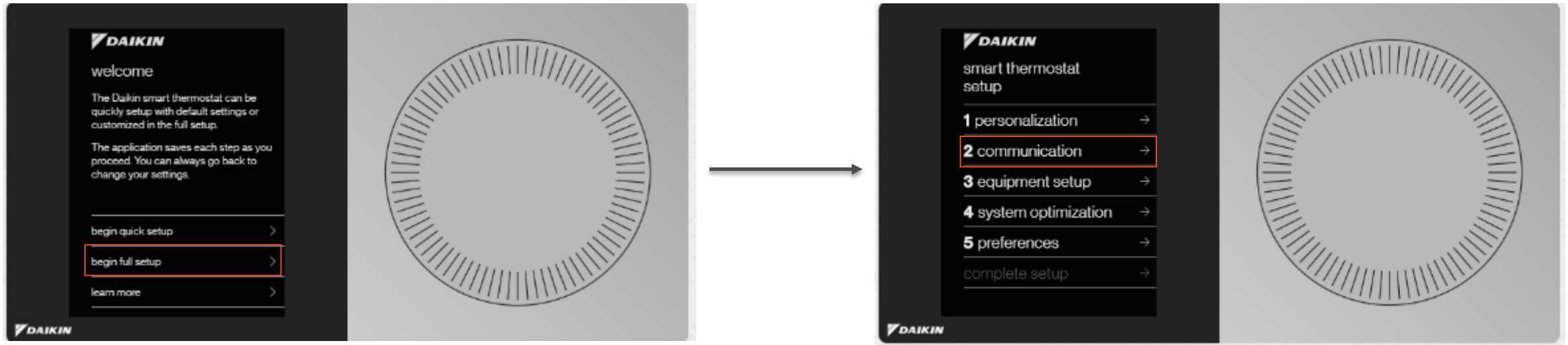

Connect to the network and software will update automatically (con't).

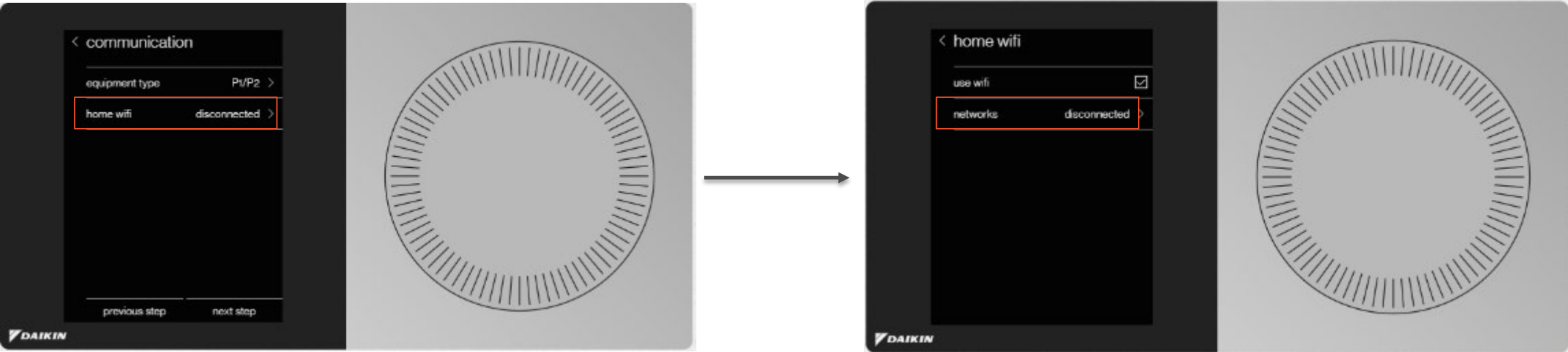

Connect to the network and software will update automatically (con't).

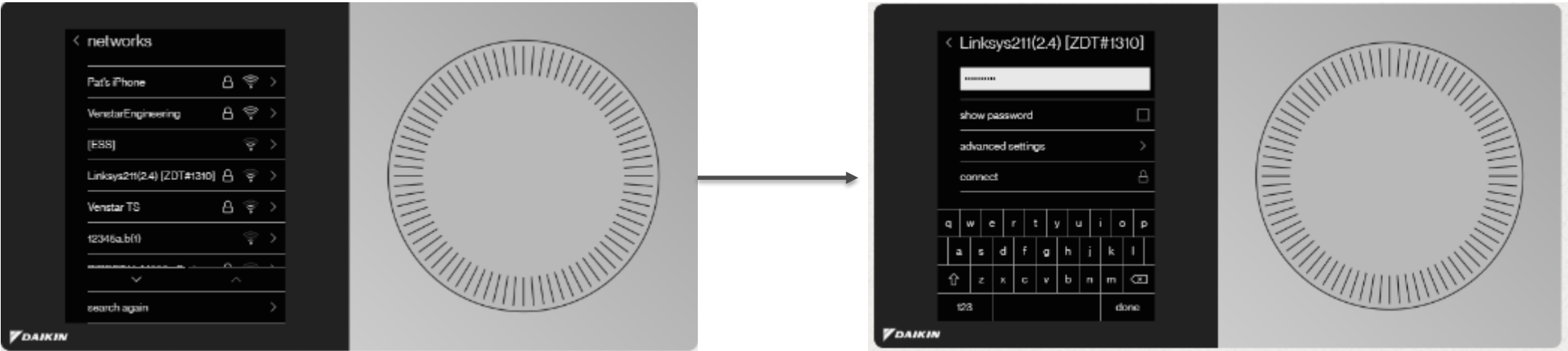

- Note: Once Wi-Fi connection is established and connected the update will be detected and load automatically.



Update will begin downloading.

When update is complete the System will automatically reboot. After it restarts you should see this welcome screen.

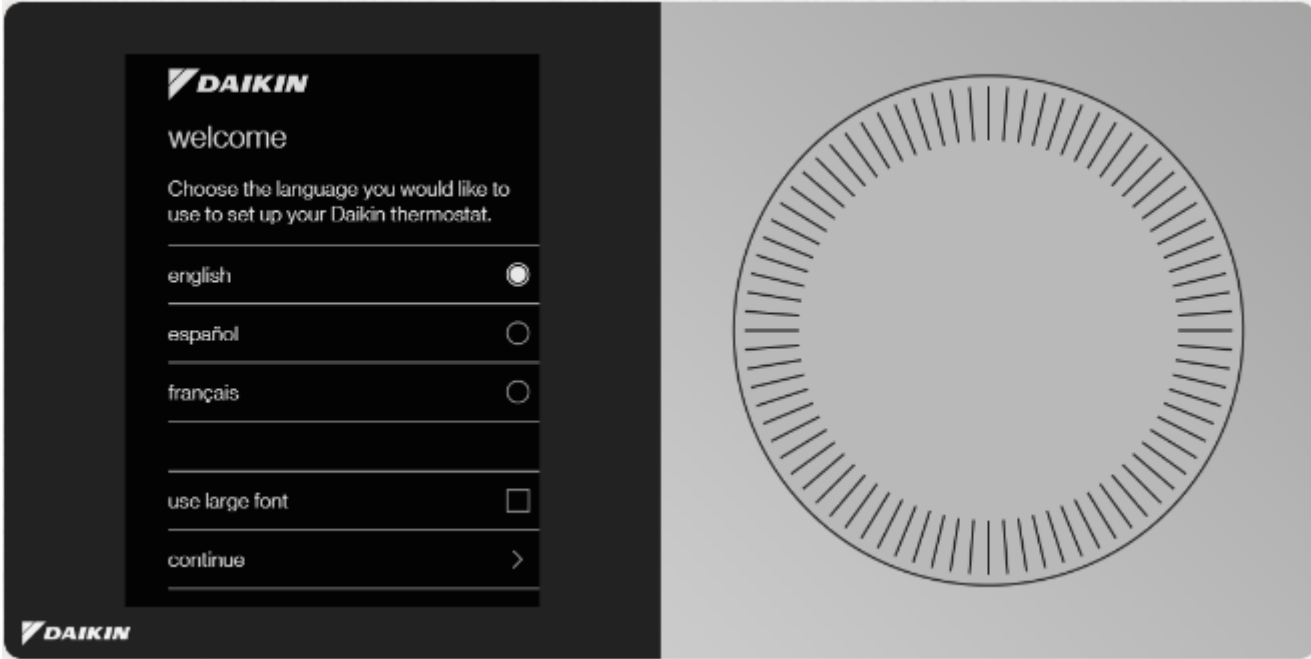

LEARN MORE AT WWW.DAIKINONE.COM